

Product Catalogue

Disposable surgical gowns, drapes and packs



NUREL MEDİKAL, established in Bursa /TÜRKİYE in 2004 shows activity in a 5.000 sqm closed production area which covers all the standards of medical sector.

The Euroset brand is the leader in Turkish market with its disposable medical textile product range, including surgical gowns, drapes and sets.

Our production area is a clean room which meets Class 100.000 standards and all process and products are certified with ISO 9001, ISO 13485, EN13795 and CE marking.

We use latest technology and full automatic spreading, cutting, packaging and labelling machines in our production and manage our sterilization process on our own site according to EN11135-1 standards.

Our sterilization machines are latest technology and working with paramethric release system. The capacity of our sterilization unit is 48 m³ per cycle.

Nurel Medical, Euroset brand, with its fastest response to customer demand; next-generation technology, total quality management system, innovation and lean manufacturing principles adopted by an experienced management team and trained employees, is moving rapidly towards its goal of becoming one of the key players in the global market.

Our production is based on customized product which are designed according to the customer's and hospital's demands or their technical specification.

We provide various options for our customers to choose, rather than force them to accept the product that we designate; we do provide professional advice & sufficient information for our customers reference.

Today, we export to 50 different countries, and the share from the global market is growing day by day.

PRODUCTS

Surgical Gowns.....	6-7
General Surgery Packs	8-11
Angiography Packs	12-13
Cardiovascular Packs.....	14-15
ENTPacks.....	16-19
General / Abdominal Packs.....	20-21
Gynaecology Packs.....	22-25
Neuro Packs.....	26-27
C-Section / Delivery Packs.....	28-31
Ophthalmic Packs.....	32-33
Orthopaedic Packs.....	34-44
Urology Packs.....	45-46
Components.....	47-50

SMS Gowns

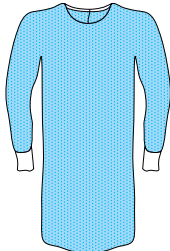

■ SMS

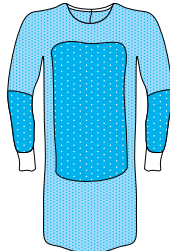

■ SMS ■ Reinforced



■ SMS

Size	Type	Reference Number
L	Standart	0003 - SMS
XL	Standart	0004 - SMS
XXL	Standart	0005 - SMS
L XLong	Standart	0006 - SMS
XL XLong	Standart	0007 - SMS
XXL XLong	Standart	0008 - SMS
Standart gown : for relatively dry procedures		
L	Polyethylene reinforced (PRF)	0202 - SMS
XL	Polyethylene reinforced (PRF)	0203 - SMS
XXL	Polyethylene reinforced (PRF)	0204 - SMS
L XLong	Polyethylene reinforced (PRF)	0205 - SMS
XL XLong	Polyethylene reinforced (PRF)	0206 - SMS
XXL XLong	Polyethylene reinforced (PRF)	0207 - SMS
Polyethylene reinforced (PRF): proofed at sleeves and chest/abdominal section, for high level wet procedures.		
Lengths SMS: L is 120 cm, XL is 132 cm, XXL is 142		
(XLong is about 12 cm longer than the regular version)		
Elastic cuffs		
Velcro neck closure		
Sterile gown is packed with towel in a paper wrap and peelable bag		
Gowns are latexfree		
Complies with the EN 13795 norm		

Spunlace Gowns



Spunlace



Spunlace Reinforced

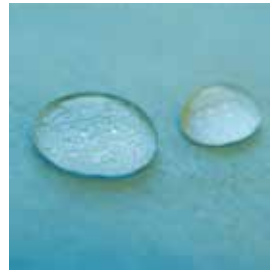

Spunlace

Size	Type	Reference Number
L	Standart	0003 - SPL
XL	Standart	0004 - SPL
XXL	Standart	0005 - SPL
L XLong	Standart	0006 - SPL
XL XLong	Standart	0007 - SPL
XXL XLong	Standart	0008 - SPL
Standart gown : for relatively dry procedures		
L	Polyethylene reinforced (PRF)	0202 - SPL
XL	Polyethylene reinforced (PRF)	0203 - SPL
XXL	Polyethylene reinforced (PRF)	0204 - SPL
L XLong	Polyethylene reinforced (PRF)	0205 - SPL
XL XLong	Polyethylene reinforced (PRF)	0206 - SPL
XXL XLong	Polyethylene reinforced (PRF)	0207 - SPL
Polyethylene reinforced (PRF): proofed at sleeves and chest/abdominal section, for high level wet procedures.		
Lenghts SMS: L is 120 cm, XL is 132 cm, XXL is 142		
(XLong is about 12 cm longer than the regular version)		
Elastic cuffs		
Velcro neck closure		
Sterile gown is packed with towel in a paper wrap and peelable bag		
Gowns are latexfree		
Complies with the EN 13795 norm		

GENERAL SURGERY PACK - 1 REF NO : 2000

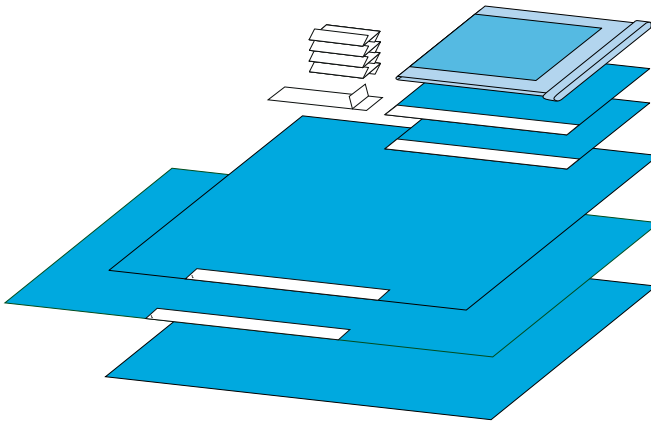

- 1 Mayo stand cover 79x145 cm
- 4 Cellulose tower 38x38 cm
- 1 Op-tape 9x49 cm
- 2 Adhesive drape 90x75 cm
- 1 Adhesive drape 180x180 cm
- 1 Adhesive drape 240x150 cm
- 1 Table cover 150x190 cm , 75x190 cm absorbent

GENERAL SURGERY PACK - 2

REF NO : 2018

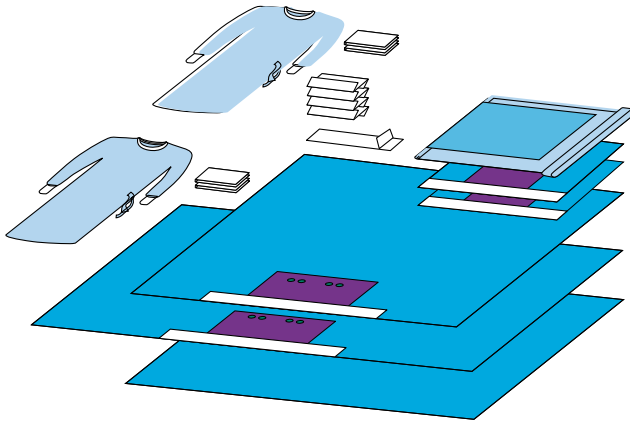

- 1 Surgical gown L + 2 hand towel 38x38 cm
- 1 Mayo stand cover 79x145 cm
- 4 Celluose towel 38x38 cm
- 2 Adhesive drape 90x75 cm
- 1 Surgical gown L + 2 hand towel 38x38 cm
- 1 Op - tape 9x49 cm
- 1 Adhesive drape 180x180 cm
- 1 Adhesive drape 240x150 cm
- 1 Table cover 150x190 cm

GENERAL SURGERY PACK - 3 REF NO : 2900

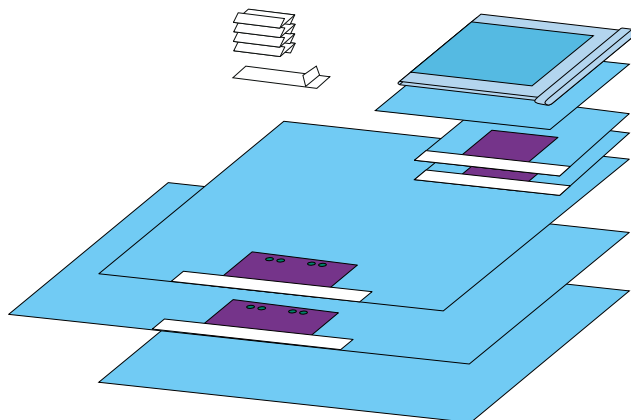

- 1 Mayo stand cover 79x145 cm
- 1 Adhesive drape 75x90 cm
- 4 Cellulose towel 38x38 cm
- 2 Adhesive drape 75x75 cm
- 1 Op - tape 9x49 cm
- 1 Adhesive drape 180x180 cm
- 1 Adhesive drape 240x150 cm
- 1 Table cover 150x190 cm

GENERAL SURGERY PACK - 4 REF NO : 2900-1

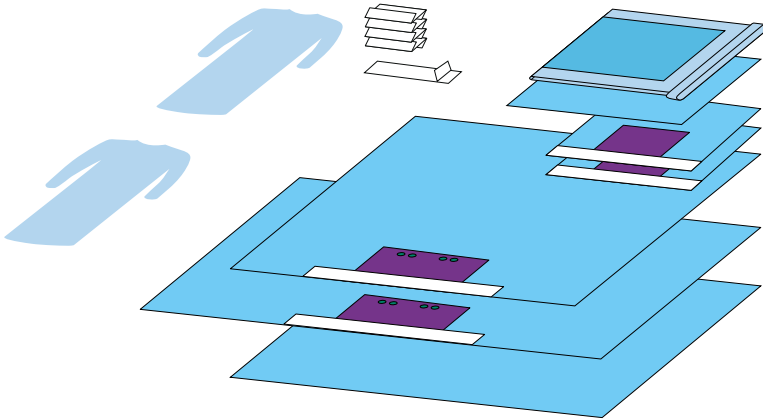

- 1 Mayo stand cover 79x145 cm
- 1 Adhesive drape 75x90 cm
- 4 Cellulose towel 38x38 cm
- 2 Standard Surgical Gown L
- 2 Adhesive drape 75x75 cm
- 1 Op - tape 9x49 cm
- 1 Adhesive drape 180x180 cm
- 1 Adhesive drape 240x150 cm
- 1 Table cover 150x190 cm

ANGIOGRAPHY PACK - FEMORAL

REF NO : 3200

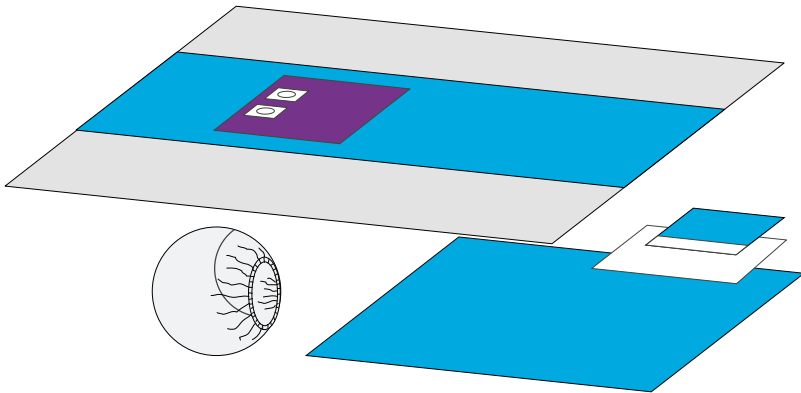

- 1 Angiography drape 240x330cm, reinforcement 70x70cm 2 apertures 7x10 cm
- 1 Adhesive drape 50x50 cm
- 1 Fluoroscopy Cover 85x105 cm
- 1 Absorption drape 60x90 cm
- 1 Table cover 150x190 cm

ANGIOGRAPHY PACK - RADIAL & FEMORAL

REF NO : 3208

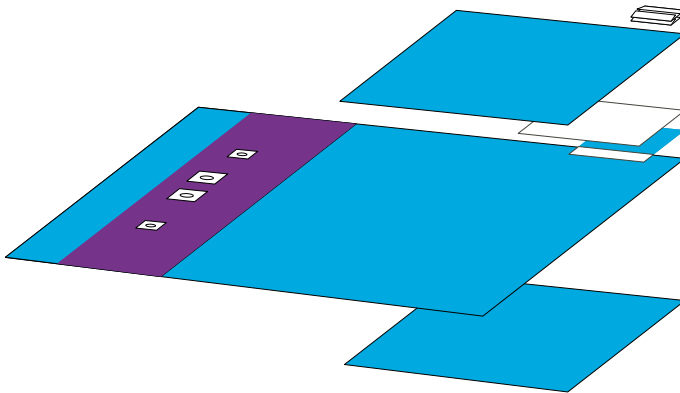

- 1 Table cover 150x140 cm
- 2 Cellulose towel 38x38 cm
- 1 Ansrption drape 60x90 cm
- 2 Adhesive drape 50x50 cm
- 1 Angiography drape 240x330 cm aptures 5x7 cm (2) and 7x9 cm (2)
- 1 Table cover 150x140 cm

THORACIC PACK

REF NO : 2005

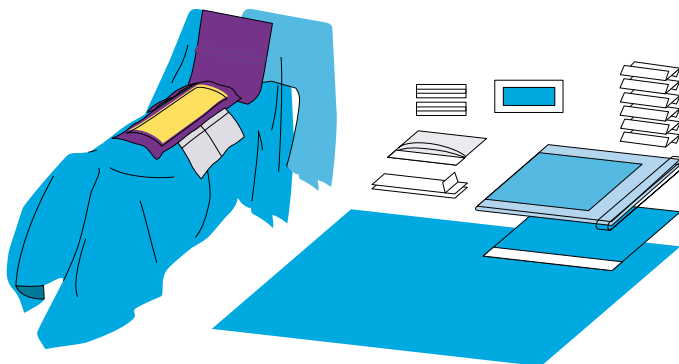

- 1 Mayo stand cover reinforced 79x145 cm
- 1 Genital cover 18x40 cm
- 6 Cellulose towel 38x38 cm
- 2 Tube holder velcro 2,5x11 cm
- 1 Adhesive drape 75x75 cm
- 1 Suture bag 33x38 cm
- 2 Op-tape 9x49 cm
- 1 Acute thoracic drape 200/300x340cm incise area 37x65cm
- 1 Table cover 150x240 cm

CARDIOVASCULAR PACK

REF NO : 2604

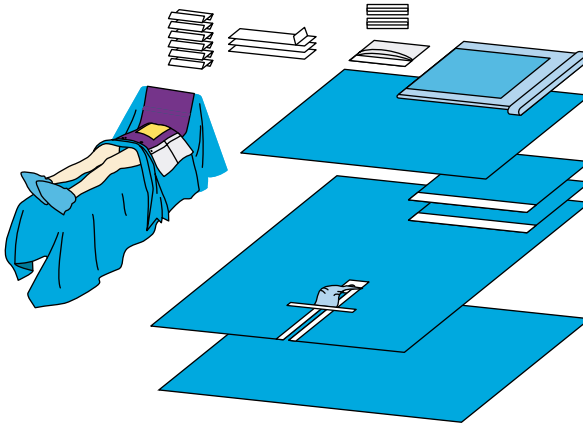

- 1 Mayo stand cover reinforced 79x145 cm
- 6 Cellulose towel 38x38 cm
- 1 Table cover 150x190 cm
- 2 Adhesive Drape 75x90 cm
- 1 Suture bag 33x38 cm
- 2 Tube holder velcro 2,5x11 cm
- 3 Op-tape 9x49 cm
- 2 Foot cover
- 1 Lower vascular drape 200x260 cm, split 20x102 cm
- 1 Thoracic drape 200/300x330 cm incise area 32x40 cm
- 1 Table cover 150x240 cm

HEAD PACK

REF NO : 3808

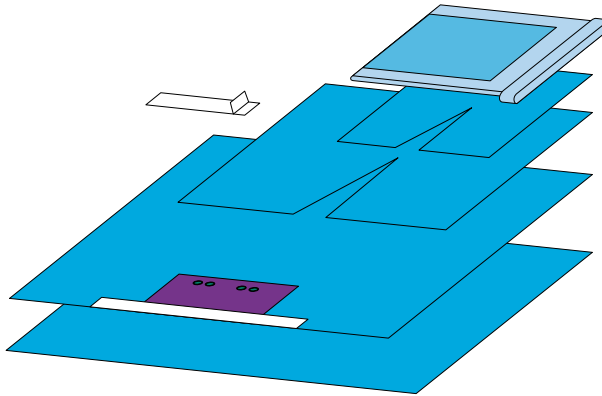

- 1 Mayo stand cover 79x145 cm
- 1 Op-tape 9x49 cm
- 1 Head drape 150x175 cm
- 1 Head drape 106x103 cm
- 1 Adhesive drape 175x175 cm
- 1 Table cover 150x190 cm

ENT PACK

REF NO : 3606

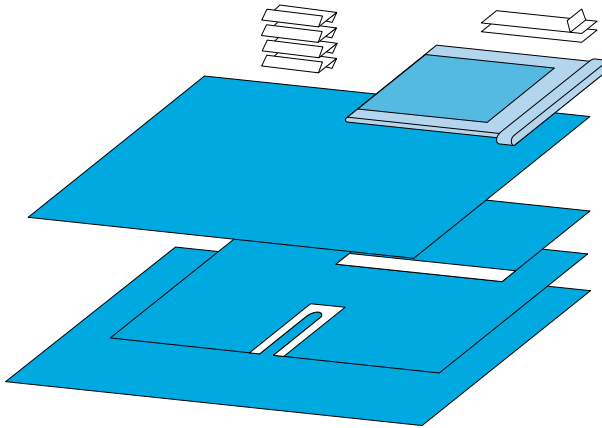

- 1 Mayo stand cover reinforced 79x145 cm
- 4 Cellulose towel 38x38 cm
- 1 Op-sheet 150x175 cm
- 1 Adhesive drape 75x75 cm
- 1 Op-tape 9x49 cm
- 1 Adhesive split sheet 150x125 cm split 7x45 cm
- 1 Table cover 150x240 cm

NECK PACK

REF NO : 3601

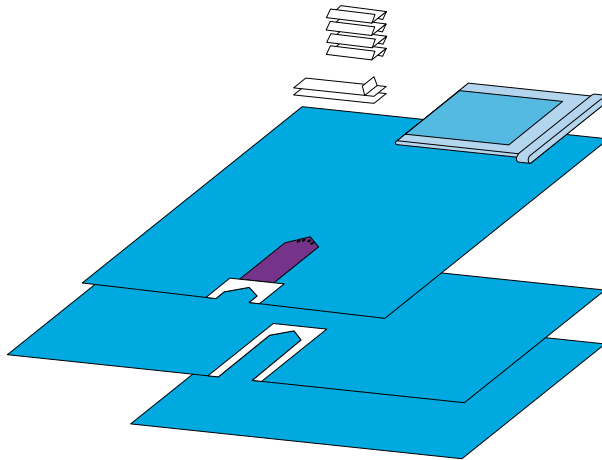

- 1 Mayo stand cover 79x145 cm
- 4 Cellulose towel 38x38 cm
- 1 Op-tape 9x49 cm
- 1 Body drape 180x230 cm, split 20x20 cm
- 1 Head drape 260x150 cm split 20x65 cm
- 1 Table cover 150x190 cm

THYROID PACK

REF NO : 3604

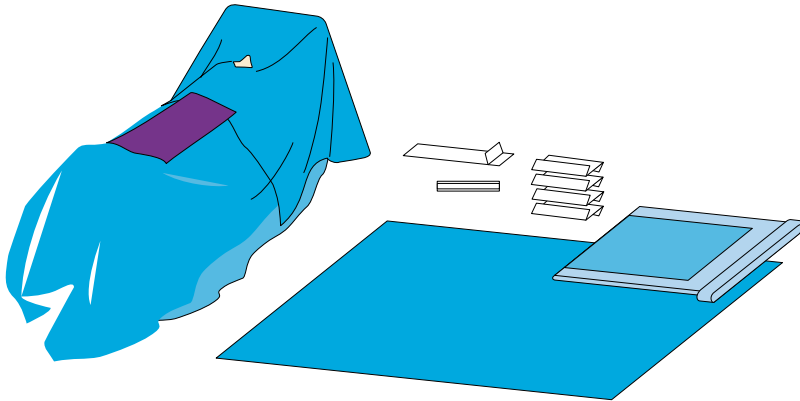

- 1 Mayo stand cover 79x145 cm
- 4 Cellulose towel 38x38 cm
- 1 Op - tape 9x49 cm
- 1 Tube holder velcro 2,5x11 cm
- 1 Adhesive aperture drape 200/280x350 cm aperture 11x11 cm
- 1 Table cover 150x190 cm

LAPAROSCOPY PACK - ABDOMINAL / PERINEAL

REF NO :2813

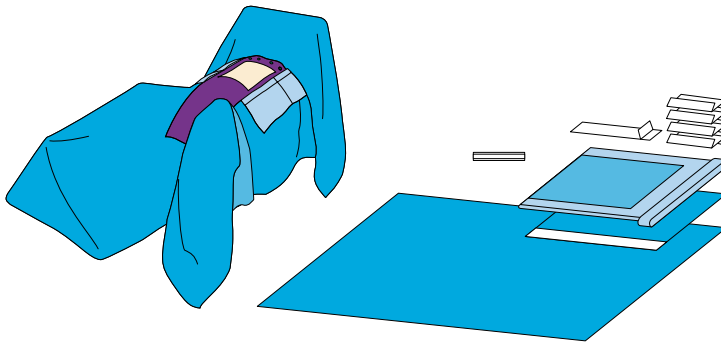

- 1 Mayo stand cover 79x145 cm
- 1 cellulose towel 38x38 cm
- 1 Op - tape 9x49 cm
- 1 Tube holder velcro 2,5x11 cm
- 1 Adhesive drape 75x75 cm
- 1 Laparoscopy drape 250/175/270x260 cm 25x30 cm and 13x24 cm
- 1 Table cover 150x190 cm

LAPAROTOMY PACK

REF NO : 3803

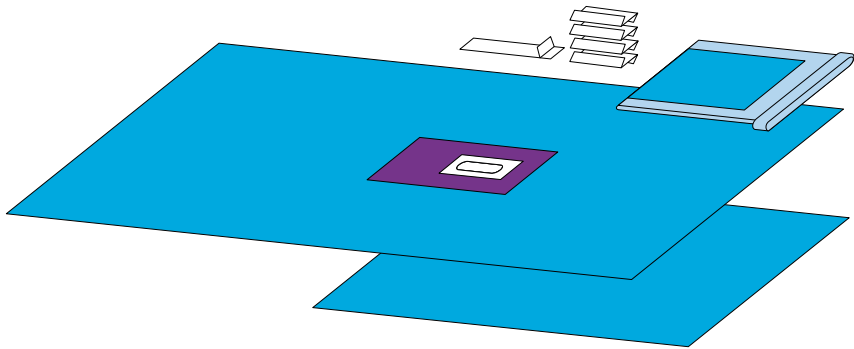

- 1 Mayo stand cover 79x145 cm
- 4 Cellulose towel 38x38 cm
- 1 Op - tape 9x49 cm
- 1 Laparoscopy drape 200x315 cm, aperture 11x22
- 1 Table cover 150x190 cm

CYSTOSCOPY PACK

REF NO :2812

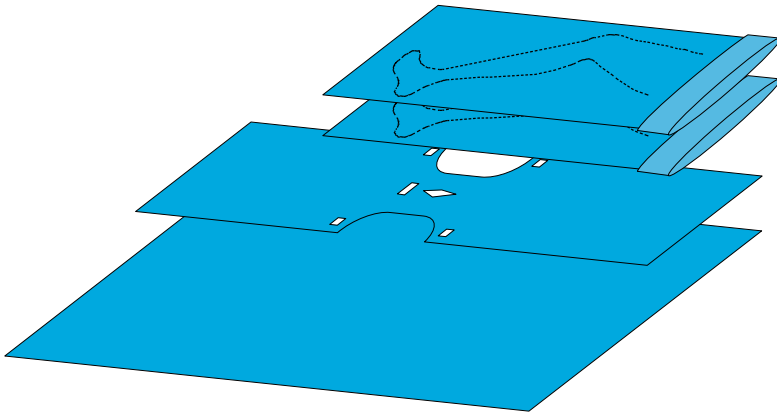

- 2 Leggings 75x120 cm
- 1 Aperture drape 75x175 cm, aperture 9x15 cm
- 1 Table cover 150x190 cm

LITHOTOMY PACK

REF NO : 2816

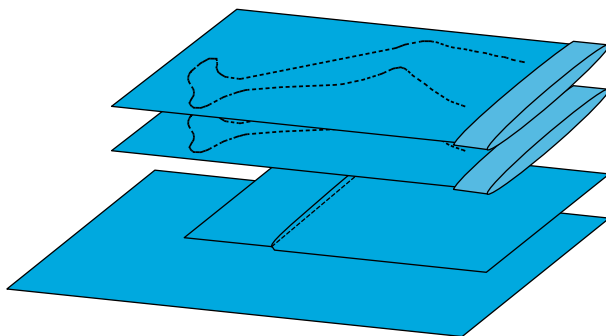

- 2 Leggings 75x120 cm
- 1 Under buttocks drape 75x100 cm
- 1 Drape 90x150 cm
- 1 Back Table Cover 150x190cm

LAPAROSCOPY PACK

REF NO :2806

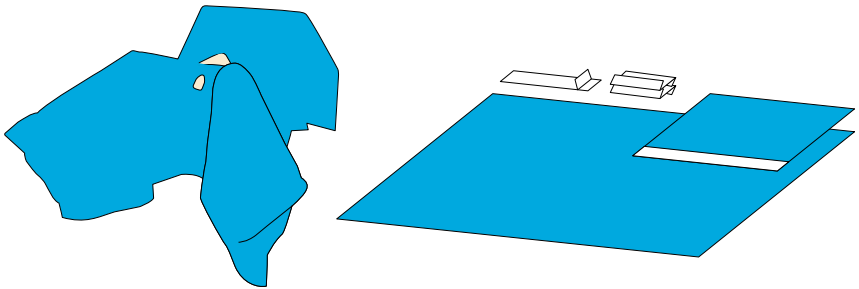

- 2 Cellulose towel 38x38 cm
- 1 Op-tape 9x49 cm
- 1 Adhesive drape 75x75 cm
- 1 Laparoscopy drape w/leggings 250/270x310 cm Triangular aperture
26x20 cm 7,5x13 cm
- 1 Table cover 150x190 cm

GYNAECOLOGY PACK

REF NO : 2405

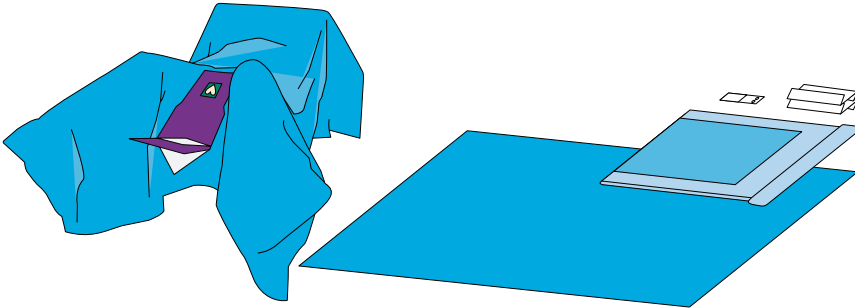

- 1 Mayo stand cover 79x145 cm
- 2 Cellulose towel 38x38 cm
- 1 Tube holder 9x18 cm
- 1 Gyn drape 60x116 cm w/pouch, aperture 8x11 cm
- 1 Base drape w/leggings 200/270x215 cm
- 1 Table cover 150x190 cm

CRANIOTOMY PACK-1

REF NO :3800-1

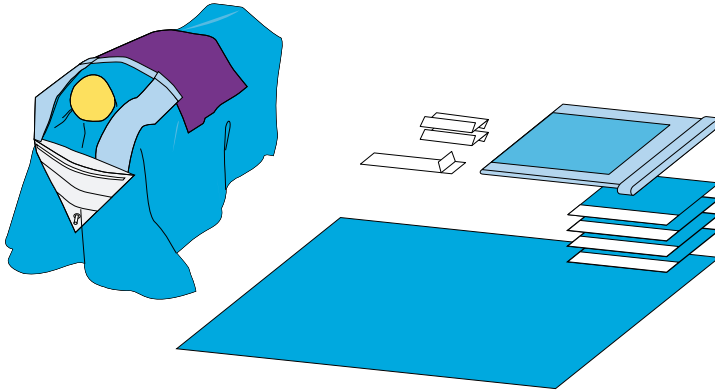

- 1 Mayo stand cover 79x145 cm
- 2 Cellulose towel 38x38 cm
- 1 Op-tape 9x49 cm
- 4 Adhesive towel 50x50 cm
- 1 Craniotomy drape 230x290 cm incise area 30x20 cm
- 1 Table cover 150x190 cm

CRANIOTOMY PACK-2

REF NO : 3800-2

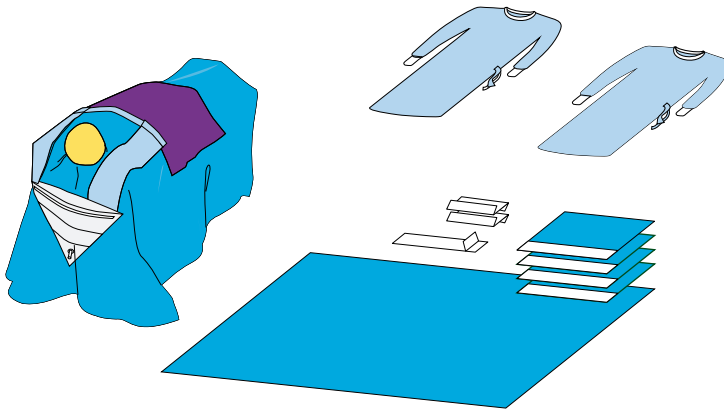

- 2 Cellulose towel 38x38 cm
- 1 Op - tape 9x49 cm
- 4 Adhesive towel 50x50 cm
- 1 Craniotomy drape 230x290 cm incise area 30x20 cm
- 1 Table cover 150x190 cm
- 2 Reinforced surgical gown large

C-SECTION PACK -1

REF NO :2204-1

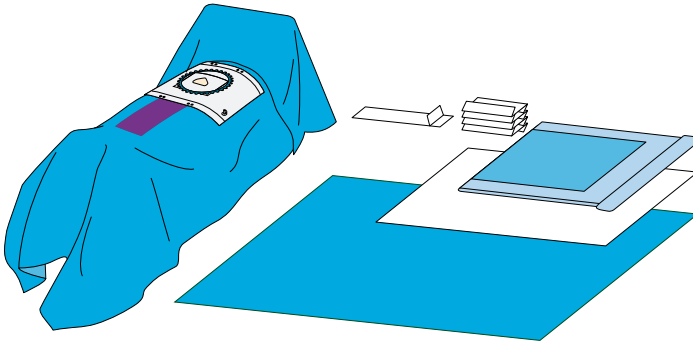

- 1 Mayo stand cover 79x145 cm
- 4 Cellulose towel 38x38 cm
- 4 Cellulose towel 38x38 cm
- 1 Op - tape 9x49 cm
- 1 Baby wrap 90x120 cm
- 1 Sectio drape 175/250x300cm incise area 38x32cm aperture 18x16cm
- 1 Table cover 150x190cm

DELIVERY PACK

REF NO :2202

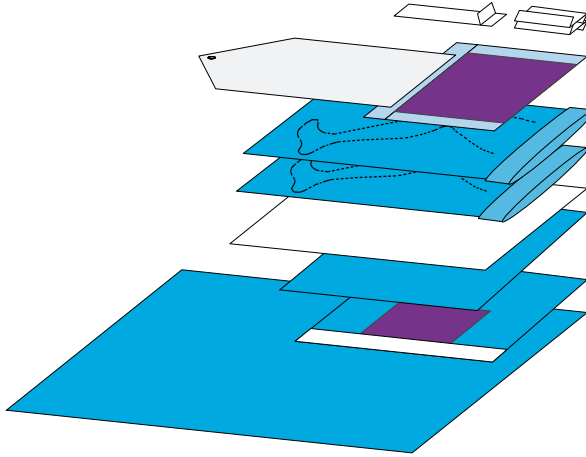

- 1 Op-tape 9x49 cm
- 2 Cellulose towel 38x38 cm
- 1 Under buttocks drape 86x112 cm with pouch
- 2 Leggings 75x120 cm
- 1 Baby wrap 100x100 cm
- 1 Utility drape 75x90 cm
- 1 Adhesive drape 75x75 cm
- 1 Table cover 150x190 cm

C-SECTION PACK-2

REF NO :2204-2

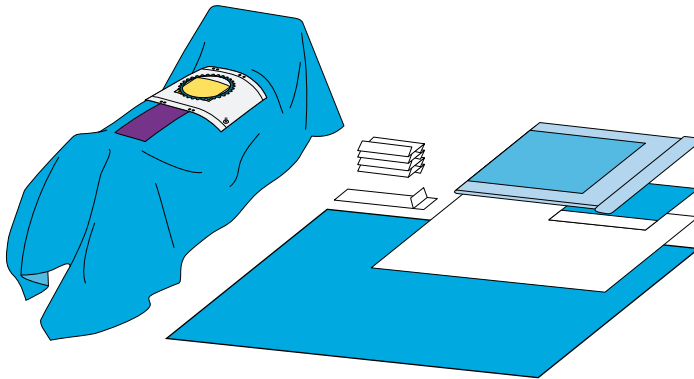

- 1 Mayo stand cover 79x145 cm
- 4 Cellulose towel 38x38 cm
- 1 Op-tape 9x49 cm
- 1 Adhesive towel 50x50 cm
- 1 Baby wrap 90x120 cm
- 1 C- section drape 175/250x300cm folded length wise,
- 1 Table cover 150x190 cm

C-SECTION PACK-3

REF NO :2204-3

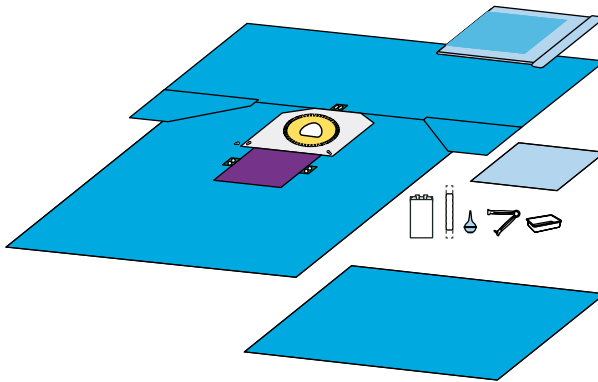

- 1 Mayo stand cover 79x145 cm
- 1 Suture bag 16.5x28.5 cm
- 1 Bulb syringe 60 ml
- 1 Towel
- 1 Cord clamp 6 cm
- 1 Placenta basin
- 1 C-section drape 196/257x325cm pouch 77x71cm,incise area 38x30cm, aperture 20x15 cm
- 1 Baby blanket 77x77 cm
- 1 Table cover 150x200 cm

OPHTHALMIC PACK-1

REF NO :4000-1

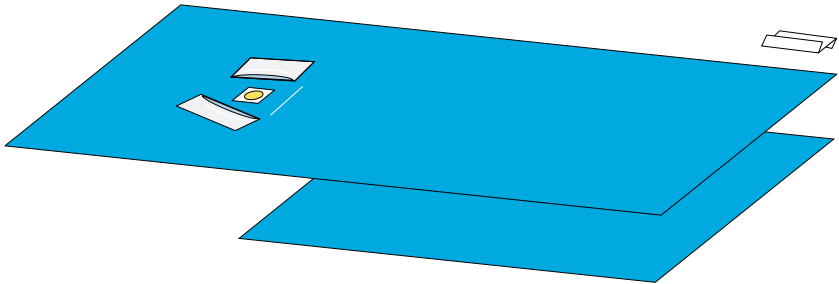

- 1 Cellulose towel 38x38 cm
- 1 Ophthalmic drape 150x300 cm w/pouches, incise area 8x10 cm
- 1 Table cover 150x190 cm

OPHTHALMIC PACK-2

REF NO :4000-2

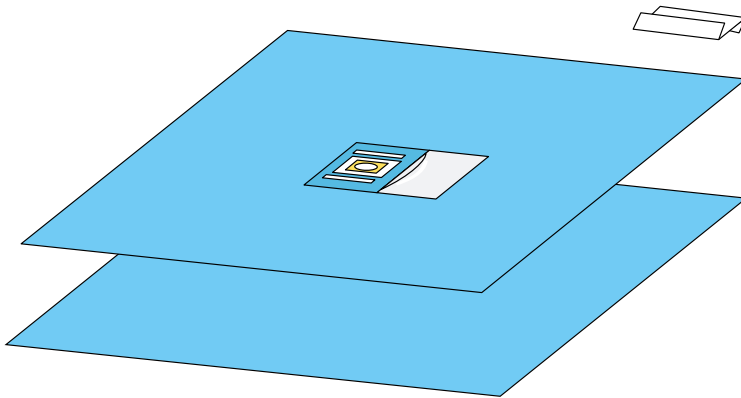

- 1 Cellulose towel 38x38 cm
- 1 Ophthalmic drape 140x150cm w/pouches, incise area 8x10cm, aperture 3,5x6,5cm
- 1 Table cover 150x190 cm

HAND / FOOT PACK

REF NO :2016

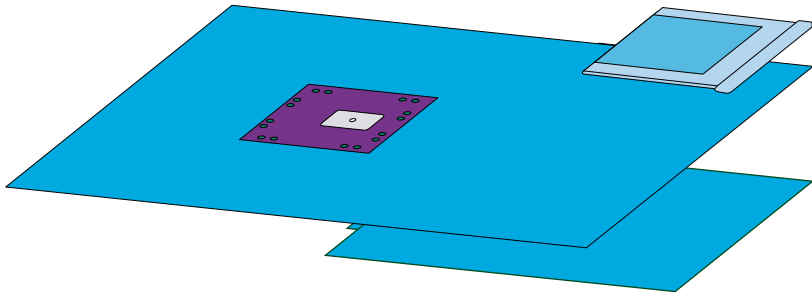

- 1 Mayo stand cover 79x145 cm
- 1 Hand & foot drape 230x315 cm 3,5 cm elastic
- 1 Table cover 150x190 cm

KNEE ARTHROSCOPY PACK

REF NO :3007

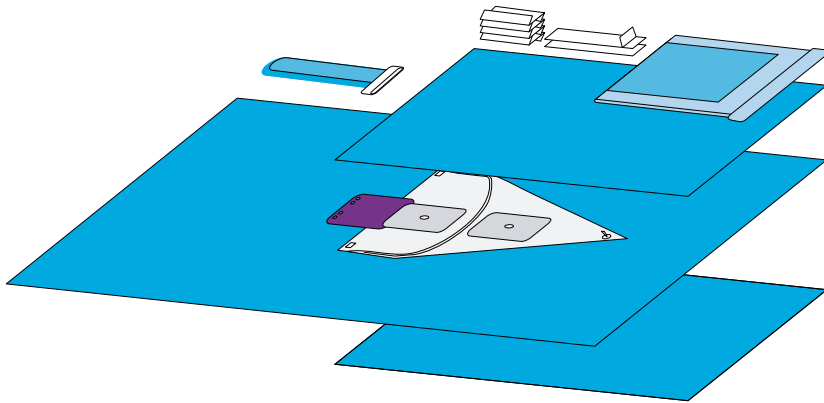

- 1 Mayo stand cover 79x145 cm
- 4 Cellulose towel 38x38 cm
- 1 Table cover 150x190 cm
- 1 Op-tape 9x49 cm
- 1 Stockinet small 22x75 cm
- 1 Knee arthroscopy drape 200x320 cm aperture 5 cm elastic
- 1 Table cover 150x190 cm

EXTREMITY PACK

REF NO :3002-1

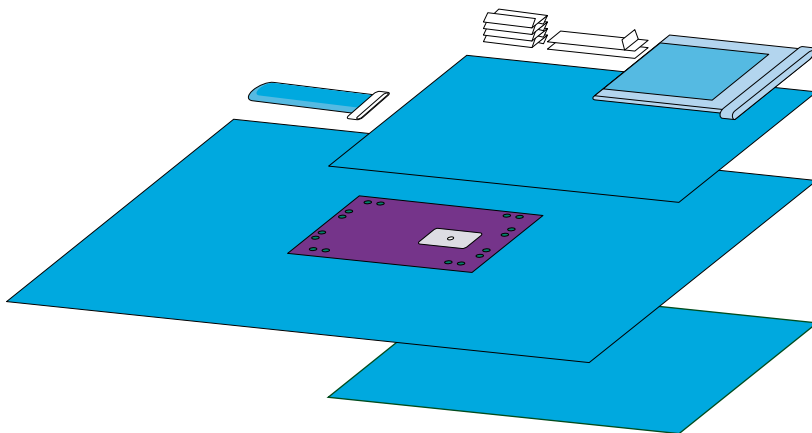

- 1 Mayo stand cover 79x145 cm
- 1 Table cover 150x190 cm
- 4 Cellulose towel 38x38 cm
- 1 Op-tape 9x49 cm
- 1 Stockinet small 22x75 cm
- 1 Extremity drape 230x315 cm, aperture 7 cm elastic
- 1 Table cover 150x190 cm

HIP PACK -1

REF NO :3003-1

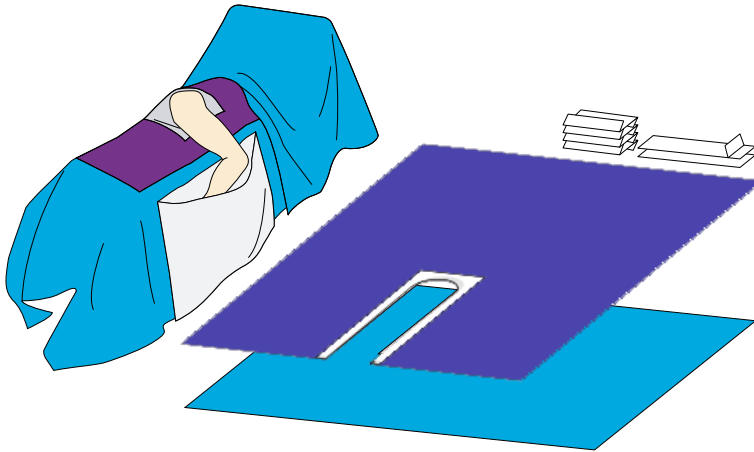

- 4 Cellulose towel 19x25 cm
- 2 Op-tabe 9x49 cm
- 1 Adhesive split drape 150x200 cm plastic, split 20x80 cm
- 1 Hip drape 230/300x350 cm, aperture 16x19 cm elastic
- 1 Table cover 150x190 cm

HIP PACK -2

REF NO :3003-2

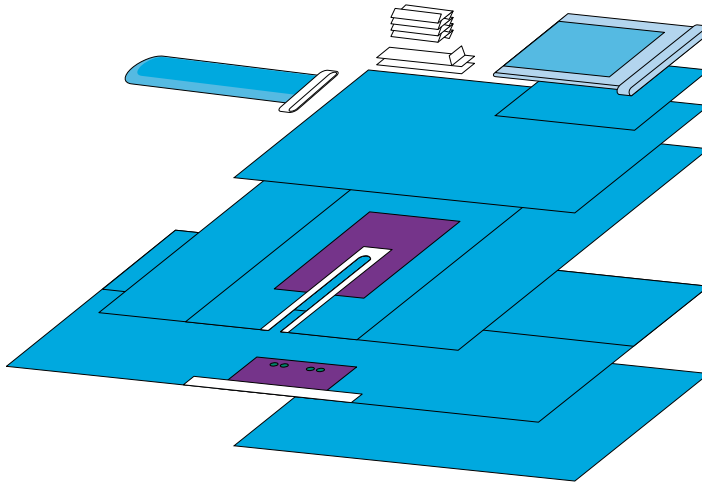

- 1 Mayo stand cover 79x145 cm
- 4 Cellulose towel 38x38 cm
- 1 Utility drape 75x90 cm
- 1 Table cover 150x190 cm
- 1 Stockinet large 32x120 cm
- 2 Op - tape 9x49 cm
- 1 Adhesive split sheet 200x260 cm split 7x102 cm
- 1 Adhesive op - sheet 300x180 cm
- 1 Table cover 150x190 cm

VERTICAL ISOLATION PACK

REF NO :1259

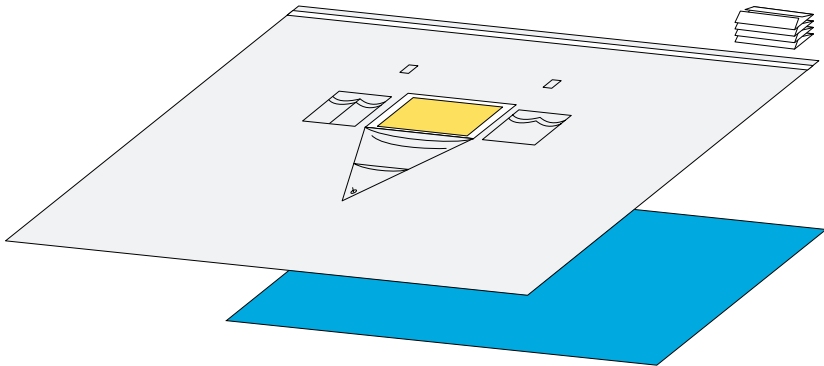

- 4 Cellulose towel 38x38 cm
- 1 Vertical isolation drape 330x240 cm, incise area 30x40 cm
- 1 Table cover 150x190 cm

UPPER EXTREMITY PACK

REF NO :3011

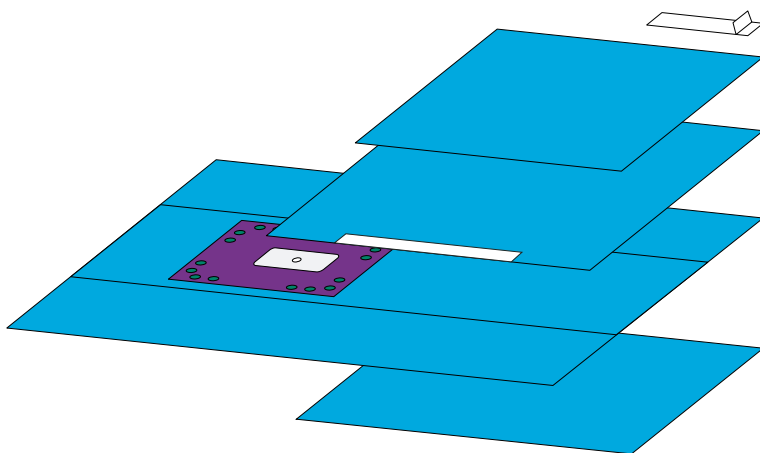

- 1 Op-tape 9x49 cm
- 1 Drape 150x175 cm
- 1 Adhesive drape 180x180 cm
- 1 Hand & foot drape 230x315 cm aperture 3,5cm elastic, patch 70x70cm
- 1 Table cover 150x190 cm

ORTHOPAEDIC PACK

REF NO :3004

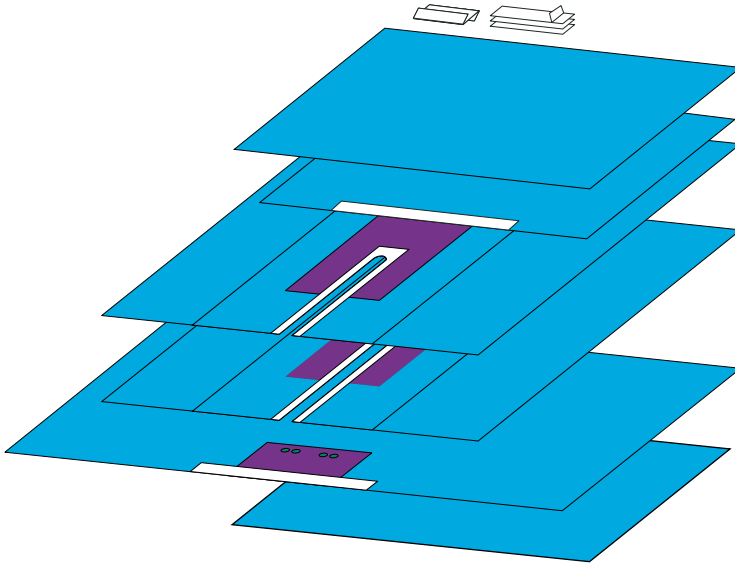

- 2 Cellulose towel 38x38 cm
- 1 Table cover 150x190 cm
- 1 Adhesive drape 175x150 cm
- 3 Op - tape 9x49 cm
- 2 Split drape 200x260 cm split 7x102 cm
- 1 Adhesive drape 300x180 cm
- 1 Table cover reinforced 150x190 cm
- 1 Wrap 100x100 cm

SHOULDER ARTHROSCOPY PACK

REF NO :3011-2

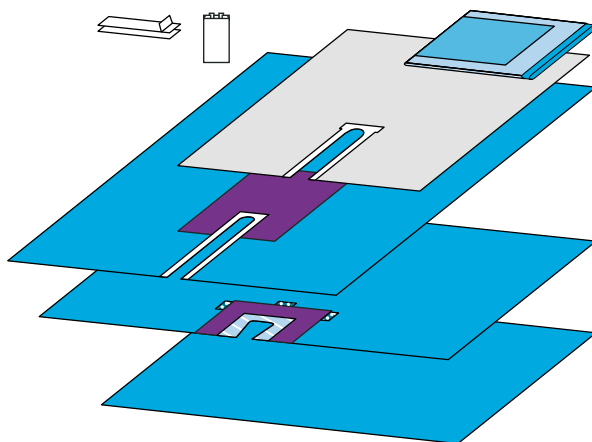

- 1 Mayo stand cover 79x145 cm
- 2 Op - tape 9x49 cm
- 1 Suture bag 16.5x28.5 cm
- 1 Adhesive split drape 150x190 cm plastic, split 15x61 cm
- 1 Body split drape 200x295 cm reinforcement 61x91 cm split 10x69 cm
- 1 Shoulder split sheet 254x180 cm split 15x20 cm
- 1 Table cover reinforced 150x200 cm

LOWER EXTREMITY PACK

REF NO :3002-2

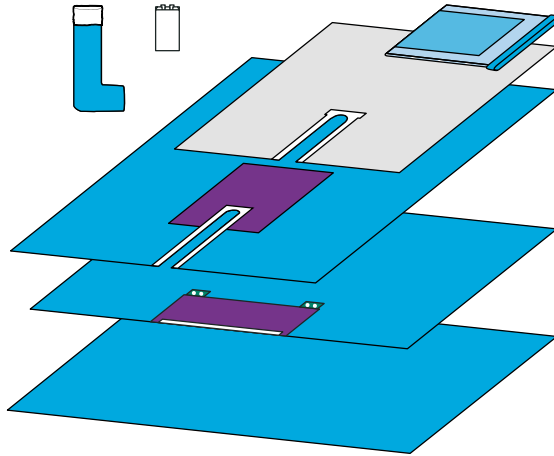

- 1 Mayo stand cover 79x145 cm
- 1 Adhesive split drape 150x190 cm plastic, split 15x61 cm
- 1 Stockinet 31x122 cm
- 1 Suture bag 16.5x28.5 cm
- 1 Adhesive split drape 200x254 cm reinforcement 46x91 cm
- 1 Adhesive Drape 150x240cm
- 1 Table cover reinforced 150x215 cm

BEACH CHAIR SHOULDER PACK

REF NO :3011-1

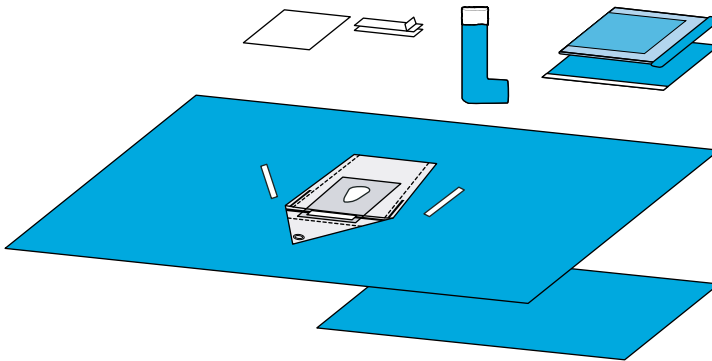

- 1 Mayo stand cover 79x145 cm
- 1 Stockinet 18x86 cm
- 2 Op-tape 9x50 cm
- 1 Adhesive utility drape 90x75 cm
- 1 Cellulose towel 50x50 cm
- 1 Beach chair shoylder drape 257x406 cm aperture 15x15 cm, elastic
- 1 Table cover reinforced 150x230 cm

SPINAL PACK

REF NO :3806

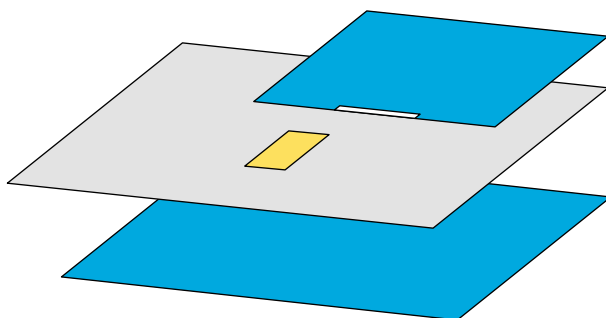

- 1 Adhesive patient drape 180x150 cm
- 1 Spinal drape 240x320 cm, incise area 30x60 cm
- 1 Table cover reinforced 150x200 cm

TUR PACK

REF NO :2814

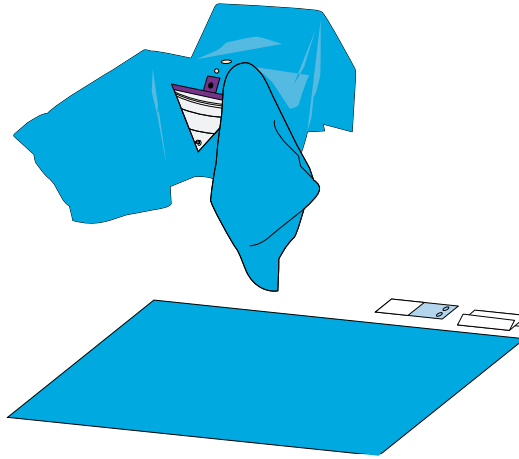

- 1 Cellulose towel 38x38 cm
- 1 Tube holder 9x18 cm
- 1 Tur drape 175x215 cm w/pouch, apertures 8 cm and 5 cm, finger cot
- 1 Table cover 150x190 cm

COMPONENTS



YANKUER SET



TRAY



TRAY OF 3



TOURNIQUET ADULT



SYRINGE LUER LOCK
20 ML



SUTURE BAG

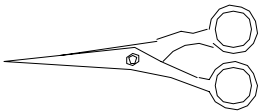

STAINLESS STEEL SCISSOR



SPONGE FORCEPS
ROUND TIP



SKIN STAPLER



SCALPEL WITH HANDLE
NO:11

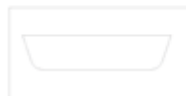

SCALPEL NO:15

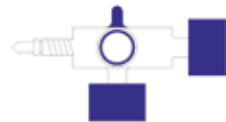

3 WAY TAP



PURPLE SKIN MARKER



PROTECTIVE COVER SQUARE



SURGICAL CAP



OP TAPE 10x50 CM



NEEDLE CABEL



NEEDLE NEST



NEEDLE 18 G



MONIFOLD SET



FACE MASK



KIDNEY BASIN 700 ML



CAMERA COVER



NEEDLE BOX



INSTRUMENT POUCH 2
COMPARTMENTS



HEMOSTATIC VALVE



GUIDEWIRE 0,038*150 3 MM JTP



GUIDEWIRE BOWL 2500 ML



GAUZE SWAPS



FORCEP



FOOT COVER



FLOUROSCOPY COVER



ELECTRIC CAUTERY PEN



ELASTIC BANDAGE



SWAB STICK



6F RADIAL INTRODUCER



BAND BLUE AND PINK



CAMERA COVER



CAMERA COVER



CANNULA FREIZER 12 FR



BOWL 500 CC



CELLULOSE 5 SPEARS
STERILLE IN ONE PACK



COTTON APPLICATOR



DISPOSABLE SHOE COVER



BETADINE SPONGE



COVER HANDLEBARS



COVER HANDLEBARS



ASPIRATION TUBE



ECCERTIFICATE

Production Quality Assurance for Medical Devices Directive 93/42/EEC Annex V

Company Name : Nurel Medikal San. ve Tic. A.Ş.

Company Address : Dosab Karanfil Sok. No:4.B. Osmangazi BURSA / TURKEY

Related Directives and Annex : MDD 93/42/EEC Medical Devices Directive - Annex V

Product : Sterile Surgical Gowns, Surgical Drapes and Drape Sets - Class II

GMDN : 47783, 35778, 35092

Product types are attached.

Certificate Number : M.2016.106.7196
 Report Number : MD.3336.TR-002
 Initial Assessment Date : 15.07.2016
 Registration Date : 23.11.2016
 Revision Date /No : 23.07.2016/ 02
 Expiry Date : 01.08.2021



UDEM hereby declares that the requirements of Annex V, of the directive 93/42/EEC have been met for the listed products. The above named manufacturer has established and carries a quality assurance system, which is subject to periodic surveillance audits, defined by Annex V, section 4 of the aforementioned directive. According to Annex V section 4, CE design registration certificate is required for placing the Class II device on the market. This certificate remains as the property of UDEM International Certification Auditing Agency and Trade Inc. Co. to whom it must be returned upon request. The above named company and UDEM must keep a copy of this certificate for 5 years from the registration of the certificate. Usage of the CE mark is under the responsibility of the manufacturer with the consultation of UDEM International Certification Auditing Agency and Trade Inc. Co. Any changes related with the approved product to UDEM. If UDEM will not renew the expiry date of this certificate in question, the mentioned company should stop placing the product on the market. The currency of the certificate can be checked through www.udem.com.tr.

Address: Nilüfer Mahallesi 2073 Sokak (Eski 93 Sokak) No:10 Çankaya - Ankara - TURKEY
 Phone: +90 0312 443 03 90 Fax: +90 0312 443 03 74
 E-mail: info@udemtr.com.tr www.udem.com.tr





CERTIFICATE

Nurel Medikal San ve Tic A.Ş.

Dosab Karanfil Sokak No:4.B. Osmangazi BURSA / TURKEY

ISO 13485:2016

Scope: Manufacture and sales of sterile and non-sterile disposable surgical drapes, surgical gowns, surgical drape packs, examination gowns and apparels, clean air suits for patients, sterile and non-sterile plastic medical devices and their sets, sterilization of the medical devices

Herby, AKSSERT Audit and Certification Ltd. Co., certifies that the above stated company gave the appropriate management system according to the requirements of the above standard. This certificate valid for 3 year's since the decision date as long as the system is effectively maintained and surveillance audits are carried out. The validity of certificate can be checked through www.akssert.com, www.iso.org/iso/ahis/. The Certificate is property of AKSSERT Audit and Certification Ltd. Co. and shall be returned if requested.

The reference standard is ISO 13485:2016

AKSSERT Audit and
Certification Ltd. Co.



Certificate Number : 85330
Registration Date : 05.12.2017

Reissue Date : 03.12.2018
Expiry Date : 04.12.2020

Adres: Mustafa Kemal Mah. 2152/1 Sokak No:5/3 Çorluysa / ANKARA-TÜRKİYE
Tel: +90 312 239 92 02 (pbx) Faks: +90 312 239 42 82
E-posta: info@akssert.com Web: www.akssert.com

